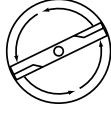

SERVICE 		5
		I0200012

IPL, ICT14, 2002-02, 106 28 16-61

JICT14A

ICT14

Spare parts

Ersatzteile

Pièces détachées

Reserve onderdelen

Repuestos

Reservdelar

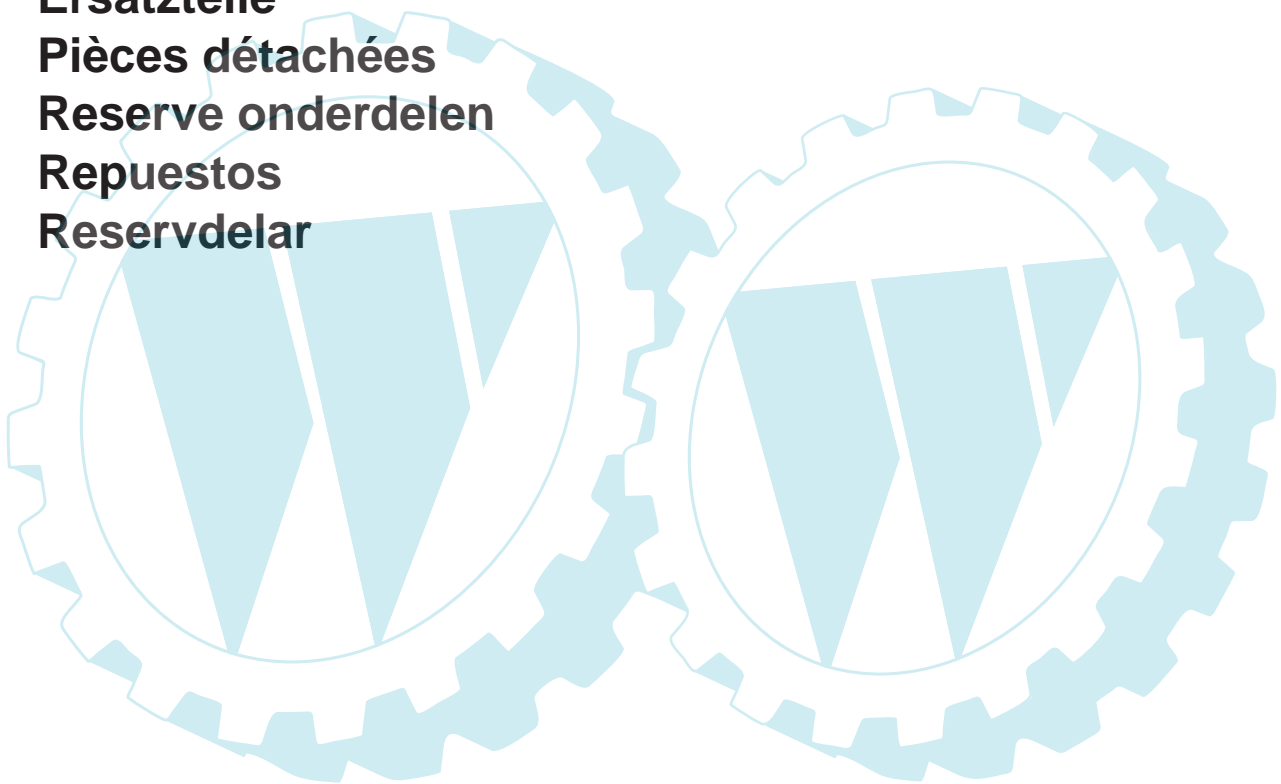

TRACTOR- -MODEL NO. ICT14 (JICT14A) PRODUCT NO. 954 13 00-64
SCHEMATIC

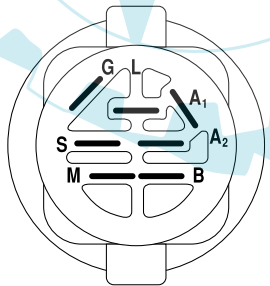
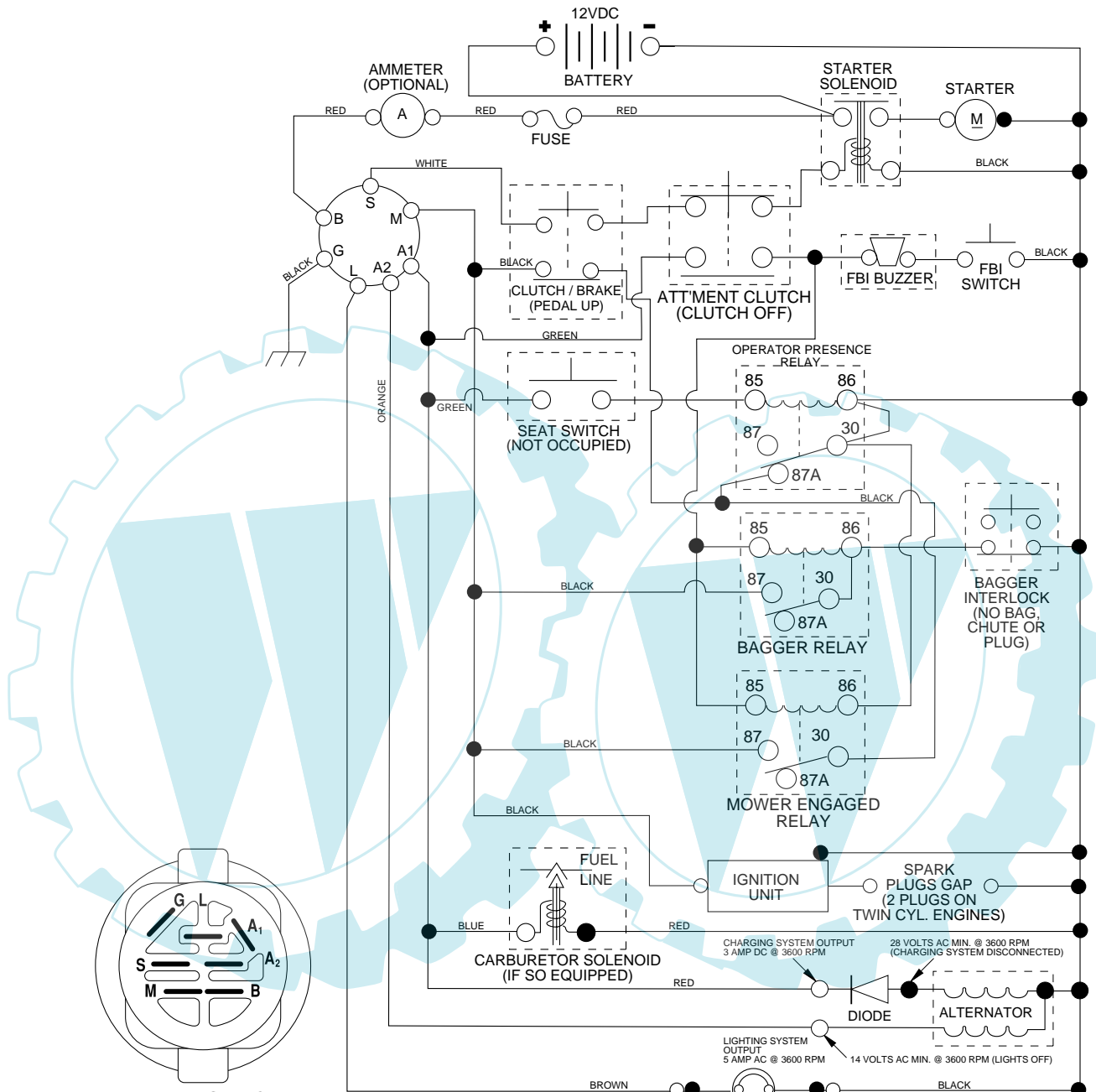

IGNITION SWITCH

POSITION	CIRCUIT	"MAKE"
OFF	M+G+A1	NONE
RUN/LIGHT	B+A1	A2+L
RUN	B+A1	NONE
START	B + S + A1	NONE

WIRING INSULATED CLIPS
NOTE: IF WIRING INSULATED CLIPS WERE REMOVED FOR SERVICING OF UNIT, THEY SHOULD BE REPLACED TO PROPERLY SECURE YOUR WIRING.

●
NON-REMOVABLE CONNECTIONS

○
REMOVABLE CONNECTIONS

PTO SWITCH

POSITION	CIRCUIT
OFF	C + G, B + H
ON	C + F, B + E, A + D

HEADLIGHTS

NOTE
YOUR TRACTOR IS EQUIPPED WITH A SPECIAL ALTERNATOR SYSTEM. THE LIGHTS ARE NOT CONNECTED TO THE BATTERY, BUT HAVE THEIR OWN ELECTRICAL SOURCE. BECAUSE OF THIS, THE BRIGHTNESS OF THE LIGHTS WILL CHANGE WITH ENGINE SPEED. AT IDLE THE LIGHTS WILL DIM. AS THE ENGINE IS SPEEDED UP, THE LIGHTS WILL BECOME THEIR BRIGHTEST.

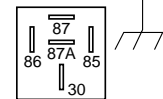

RELAY

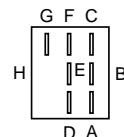

REPAIR PARTS

TRACTOR- -MODEL NO. ICT14 (JICT14A) PRODUCT NO. 954 13 00-64
ELECTRICAL

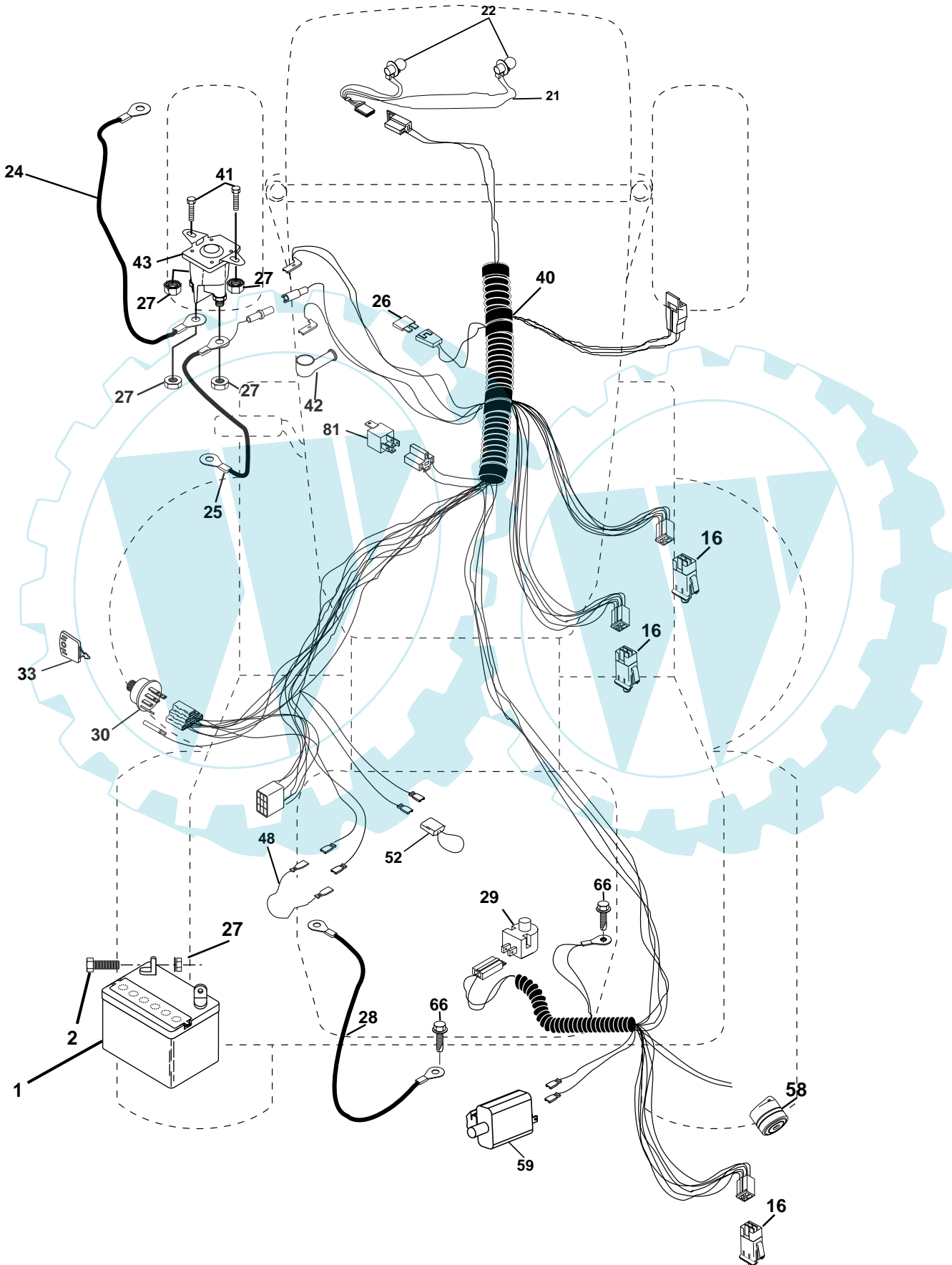

REPAIR PARTS

TRACTOR- -MODEL NO. ICT14 (JICT14A) PRODUCT NO. 954 13 00-64
ELECTRICAL

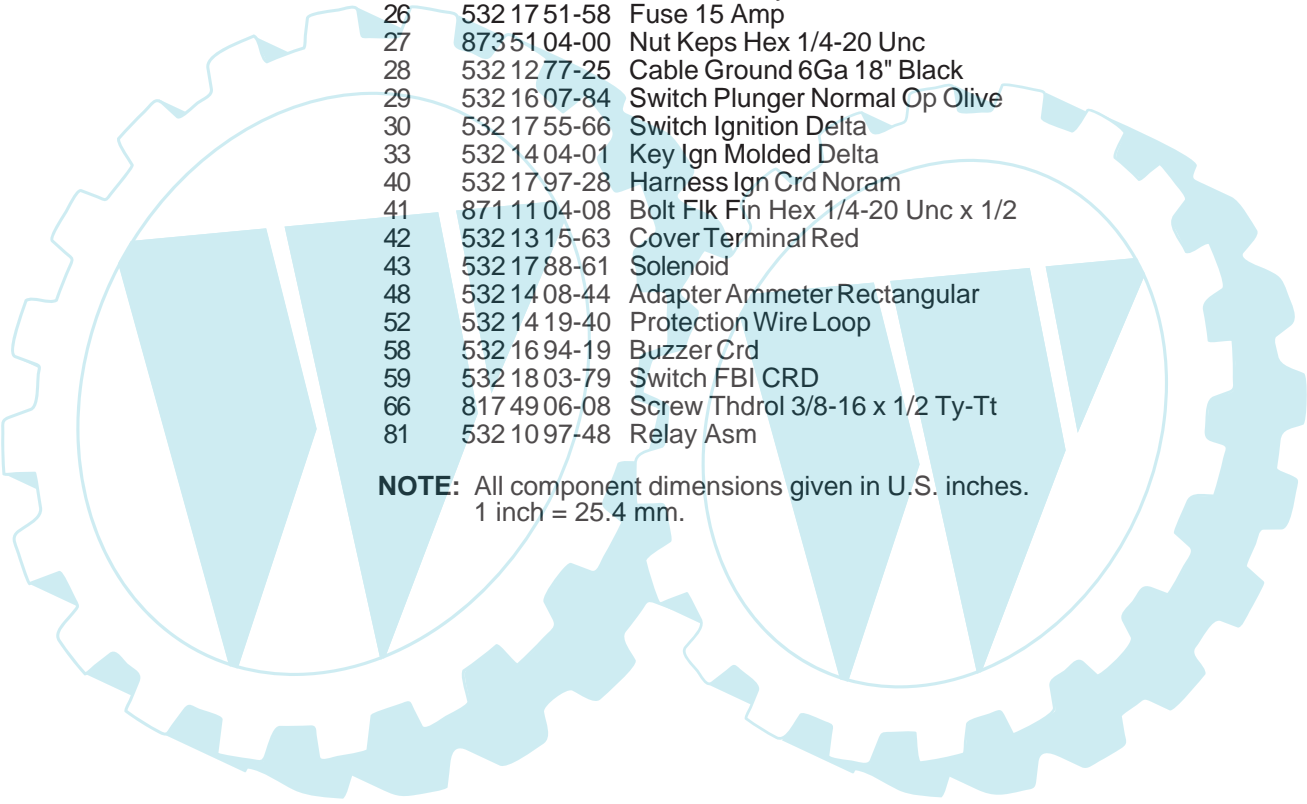

KEY NO.	PART NO.	DESCRIPTION
1	532 16 34-65	Battery 12 Volt 25 AMP Wet
2	874 76 04-12	Bolt Hex Hd 1/4-20 Unc x 3/4
16	532 17 61-38	Switch Interlock Push-In
21	532 17 56-88	Harness Asm Light W/4152J
22	532 00 41-52	Bulb Light #1156
24	532 12 47-80	Cable Starter 6Ga 11" Red
25	532 16 59-87	Cable Battery Crd 56" Red
26	532 17 51-58	Fuse 15 Amp
27	873 51 04-00	Nut Keps Hex 1/4-20 Unc
28	532 12 77-25	Cable Ground 6Ga 18" Black
29	532 16 07-84	Switch Plunger Normal Op Olive
30	532 17 55-66	Switch Ignition Delta
33	532 14 04-01	Key Ign Molded Delta
40	532 17 97-28	Harness Ign Crd Noram
41	871 11 04-08	Bolt Flk Fin Hex 1/4-20 Unc x 1/2
42	532 13 15-63	Cover Terminal Red
43	532 17 88-61	Solenoid
48	532 14 08-44	Adapter Ammeter Rectangular
52	532 14 19-40	Protection Wire Loop
58	532 16 94-19	Buzzer Crd
59	532 18 03-79	Switch FBI CRD
66	817 49 06-08	Screw Thdrol 3/8-16 x 1/2 Ty-Tt
81	532 10 97-48	Relay Asm

NOTE: All component dimensions given in U.S. inches.
1 inch = 25.4 mm.

REPAIR PARTS

TRACTOR- -MODEL NO. ICT14 (JICT14A) PRODUCT NO. 954 13 00-64
CHASSIS AND ENCLOSURES

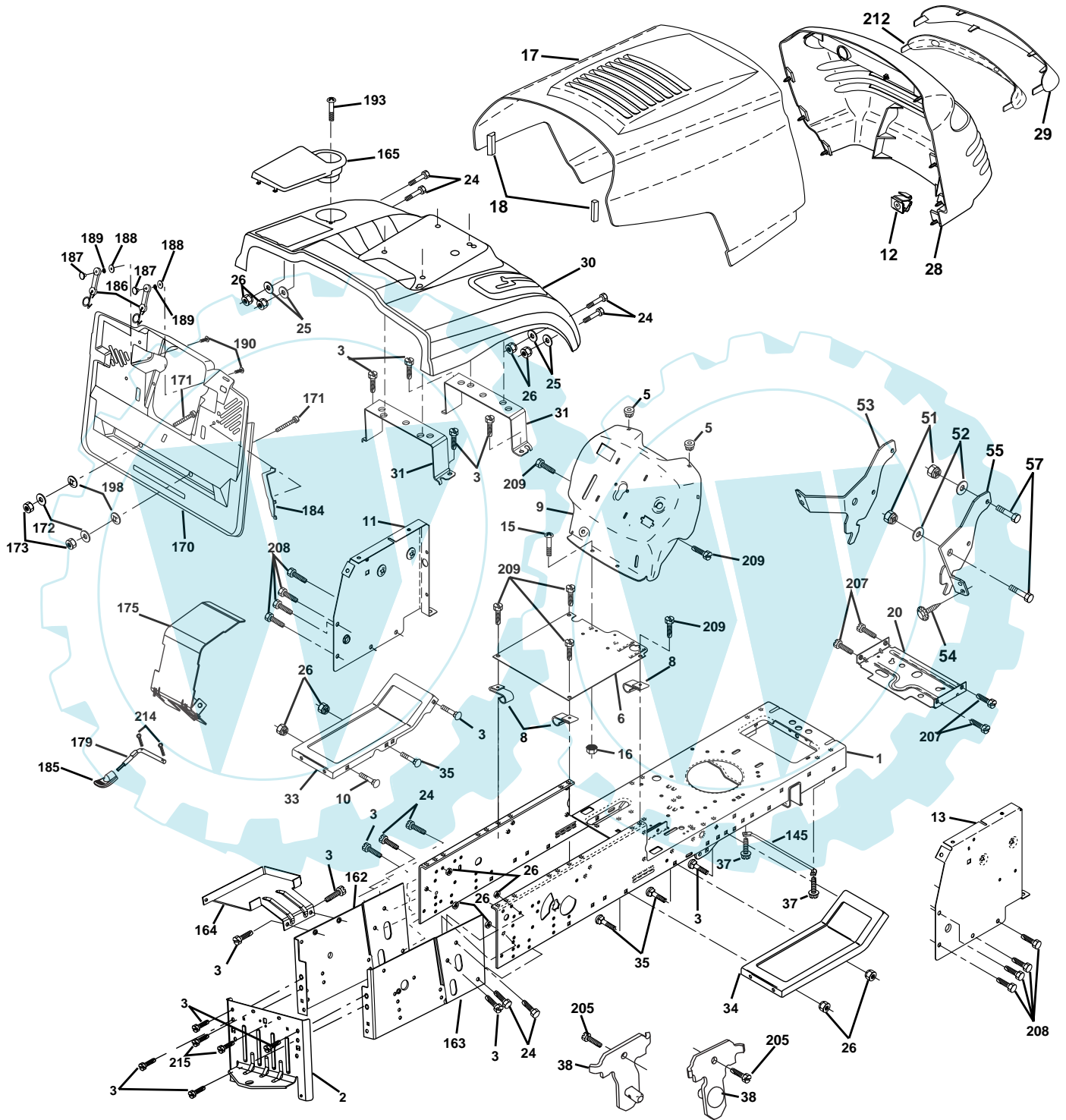

REPAIR PARTS

TRACTOR- -MODEL NO. ICT14 (JICT14A) PRODUCT NO. 954 13 00-64 CHASSIS AND ENCLOSURES

Correction:

KEY NO

30 532 18 13-59

KEY NO.	PART NO.	DESCRIPTION	KEY NO.	PART NO.	DESCRIPTION
1	532 17 46-20	Chassis Assembly	55	532 14 52-02	Bracket Grille Pick-off RH
2	532 18 03-84	Drawbar	57	874 78 04-12	Bolt, Fin Hex 1/4-20 UNC x .75
3	817 06 06-12	Screw 3/8-16 x .75 smqml Tap/R.Z	145	532 15 65-24	Rod Pivot Chassis/Hood
5	532 15 52-72	Bumper Hood/Dash	162	532 18 03-82	Bracket Exten Chassis Lh CRD
6	532 15 59-23	Saddle	163	532 18 03-83	Bracket Exten Chassis Rh CRD
8	532 12 64-71	Clip Insulator 13/32 Mtg. Hole	164	532 16 56-05	Support Battery CRD
9	532 17 22-43	Dash	165	532 16 84-07	Cover Battery CRD Lt
10	872 14 06-08	Bolt, Carriage 3/8-16 x 3/4	170	532 17 90-53	Backplate
11	532 15 59-27	Panel, Dash, L.H.	171	872 14 06-20	Bolt Hex 3/8-16 x 2-1/2 Gr. 5
12	532 14 56-60	Clip Tinnerman Grille P/L	172	819 13 20-16	Washer 13/32 x 1-1/4 x 16 Ga.
13	532 17 21-08	Panel, Asm. Dash R.H.	173	873 51 06-00	Nut, Keps Hex 3/8-16 UNC
15	874 18 05-12	Screw, Machine, Truss Head 5/16-18 UNC x 3/4	175	532 18 03-10	Guard Door Rear CRD
16	873 51 05-00	Nut	179	532 18 03-76	Rod Pivot FBI CRD
17	532 15 07-60	Hood Assembly	184	532 17 46-62	Bracket Actuator Bagger CRD
18	532 12 69-38	Bumper Hood	185	532 18 11-01	Knob Rod Brake Parking
20	532 18 06-79	Plate Mtg. Battery/Fuel Tank	186	532 16 07-93	Latch Asm Mulch/Bagger
24	874 78 06-16	Bolt	187	532 12 50-04	Nut Weld
25	819 13 13-12	Washer 13/32 x 13/16 x 12 Gauge	188	819 06 12-16	Washer #10
26	873 80 06-00	Nut	189	810 07 10-00	Washer Lock #10
28	532 17 93-51	Grille/Lens Asm	190	871 08 10-10	Screw Pan Hd Phillip 10-24 x 5/8
29	532 17 90-14	Lens, Grille	193	817 07 04-12	Screw Truss 1/4-20 x 3/4
30	532 18 13-59	Fender	198	532 16 89-37	Nut Push
31	532 16 51-56	Bracket, Fender Support	205	817 49 06-08	Screw
33	532 18 11-93	Footrest, L.H.	207	817 67 05-08	Screw Thdrol 5/16-18 x 1/2
34	532 18 11-94	Footrest, R.H.	208	817 67 06-08	Screw Thdrol 3/8-16 x 1/2
35	872 11 06-06	Bolt	209	817 00 06-12	Screw Hex Wsh Thdrol 3/8-16
37	817 49 05-08	Screw Thdrol 5/16-18 x 1/2 TYT	212	532 16 59-19	Insert Lens Reflective
38	532 17 57-10	Pivot Bracket Assembly	214	532 12 47-88	Retainer Spring 1" Zinc
51	873 80 04-00	Nut Lock w/Insert 1/4-20 UNC	215	817 06 05-08	Screw 5/16-18 x 1/2
52	819 09 14-16	Washer 9/32 x 7/8 x 16 Ga.			
53	532 14 52-01	Bracket Grille Pick-off LH			
54	532 16 14-64	Screw Hex Wshd 8-18 x 7/8			

NOTE: All component dimensions given in U.S. inches.
1 inch = 25.4 mm.

REPAIR PARTS

TRACTOR- -MODEL NO. ICT14 (JICT14A) PRODUCT NO. 954 13 00-64
DRIVE

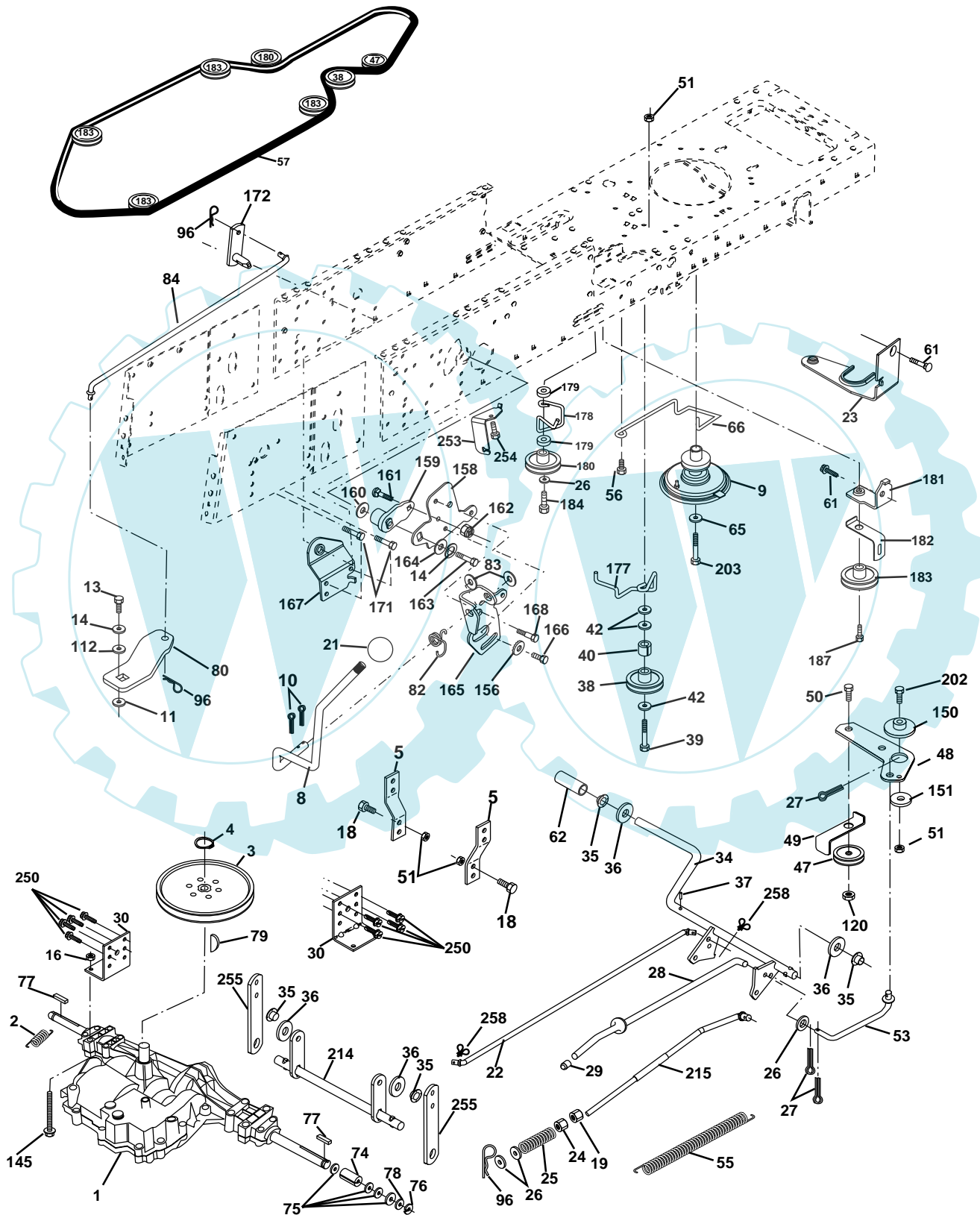

REPAIR PARTS

TRACTOR- -MODEL NO. ICT14 (JICT14A) PRODUCT NO. 954 13 00-64

DRIVE

KEY NO.	PART NO.	DESCRIPTION	KEY NO.	PART NO.	DESCRIPTION
1	-----	Transaxle Peerless 206-546 (Order parts from transaxle manufacturer)	76	8120000-01	Ring, E
2	532 14 66-82	Spring Brake Return	77	532 12 35-83	Key, Square
3	532 16 59-99	Pulley Transaxle	78	532 12 17-48	Washer 25/32 x 1-5/8 x 16 Ga.
4	8120000-28	Ring Retainer #5100-62	79	532 12 50-96	Key Woodruff
5	532 12 15-20	Strap torque 30 degrees	80	532 14 50-90	Arm Shift PMST 20" Tires
8	532 16 56-19	Rod Shift Fender Adjust Lt	82	532 12 37-82	Spring, Torsion
9	532 17 01-63	Clutch Noram	83	819 17 12-16	Washer 17/32 x 3/4 x 16 Ga.
10	8760204-16	Pin, Cotter 1/8 x 1	84	532 16 56-21	Link Shift CRD Pmst 18" Tires
11	532 10 57-01	Washer Plate Shf .3888 sq hole	96	532 12 47-88	Spring, Retainer 1"
13	874 55 04-12	Bolt 1/4-28 Unf Gr 8 w/patch	112	819 09 12-10	Washer 9/32 x 3/4 x 10 Ga.
14	810 04 04-00	Washer, Lock Hvy Helical	120	873 90 06-00	Nut Lock Flg. 3/8-16 UNC
16	873 80 05-00	Nut, Lock Hex w/Ins 5/16-18 UNC	145	874 49 05-40	Bolt Hex FGHD 5/16-18 x Gr 5
18	874 78 06-16	Bolt Hex 3/8-16 UNC x 1 Gr.5	150	532 16 58-50	Bushing, Bellcrank Grnd Dr
19	873 80 06-00	Nut, Lock Hex w/Wsh 3/8-16 UNC	151	819 13 32-10	Washer 13/32 x 2 x 10 Ga.
21	532 10 69-33	Knob Rd 1/2-13 Plstc Thds Blk	156	532 16 60-02	Washer Srred 5/16 ID x 1.125
22	532 17 56-07	Rod, Brake CRD	158	532 16 55-89	Bracket Shift Mount
23	532 18 03-02	Bracket Pnt Clutch Noram	159	532 16 54-94	Hub Tapered Flange Shift Lt
24	873 35 06-00	Nut	160	819 29 20-16	Washer 29/32 x 1-1/4 x 16 Ga.
25	532 10 68-88	Spring, Rod, Brake	161	872 14 04-06	Bolt Rdhd Sqnk 1/4-20 x 3/4 Gr 5
26	819 13 13-16	Washer 13/32 x 13/16 x 16 Ga.	162	873 68 04-00	Nut Crownlock 1/4-20 Unc
27	8760204-12	Pin, Cotter 1/8 x 3/4	163	874 78 04-16	Bolt Hex Fin 1/4-20 Unc x 1 Gr 5
28	532 17 57-65	Rod, Parking Brake	164	819 09 10-10	Washer 5/8 x .281 x 10 Ga.
29	532 07 16-73	Cap, Brake Parking Black	165	532 16 56-23	Bracket Pivot Lever
30	532 17 49-73	Bracket, Mfg. Transaxle	166	532 16 68-80	Screw 5/16-18 x 5/8
34	532 17 55-78	Shaft, Asm Pedal Foot	167	532 16 55-88	Bracket Support Shift CRD
35	532 12 01-83	Bearing, Nylon	168	532 16 54-92	Bolt Shoulder 5/16-18 x .561
36	819 21 16-16	Washer 21/32 x 1 x 16 Ga.	171	817 49 06-08	Screw Thdrol 3/8-16 x 1/2 Ty-Tt
37	532 12 49-63	Pin, Roll 3/16 x 1"	172	532 16 56-35	Shaft Asm Shift Front CRD PMST
38	532 16 59-36	Pulley, Flat	177	532 16 59-32	Keeper Flat Idler 3.06" CRD
39	874 76 06-44	Bolt Fin Hex 3/8-16 Unc x 2-3/4	178	532 16 59-33	Keeper Belt Idler 1.88" CRD
40	532 12 49-65	Spacer, Split 395 x 59 Bzp	179	532 12 09-58	Washer Sintered
42	819 13 13-12	Washer 13/32 x 13/16 x 12 Ga.	180	532 16 56-30	Pulley Flat Idler
47	532 12 77-83	Pulley, Idler, V Groove Plasic	181	532 18 02-11	Bracket Idler Ground Drive CRD
48	532 15 44-07	Bellcrank Clutch Grnd Drv	182	532 16 56-34	Keeper Belt 2.5" Od V-Idler CRD
49	532 12 32-05	Retainer, Belt Style Spring	183	532 17 90-50	Pulley V-Idler
50	874 76 06-24	Bolt Hex Hd 3/8-16 UNC x 1-1/2	184	817 49 06-44	Screw Hexwsh Thdrol 3/8-16 x 2-3/4
51	873 68 06-00	Nut, Crownlock 3/8-16 UNC	187	817 58 05-20	Screw 5/16-18 x 1.25
53	532 10 57-10	Link, Clutch 7.66	202	872 11 06-12	Bolt Carr Sh 3/8-16 x 1-1/2 Gr. 5
55	532 10 57-09	Spring, Return, Clutch	203	871 17 07-80	Bolt Hex 7/16-20 x 5
56	817 06 06-20	Screw 3/8-16 x 1-1/4	214	532 17 56-09	Shaft Asm Brake
57	532 16 56-31	V-Belt Kev PMST CRD	215	532 17 56-51	Rod Brake Secondary
61	817 06 06-12	Screw 3/8-16 x 3/4	250	817 06 06-12	Screw 3/8-16 x .75
62	532 12 48-72	Cover, Pedal	253	532 17 50-28	Bracket Cable Chassis
65	810 04 07-00	Washer	254	817 06 06-16	Screw 3/8-16 x 1
66	532 15 47-78	Keeper, Belt Engine F-Proof	255	532 17 56-08	Brace Shaft Brake Mtg.
74	532 13 70-57	Spacer Axle	258	532 17 80-62	Clip Retainer
75	532 12 17-49	Washer 25/32 x 1-1/4 x 16 Ga.			

NOTE: All component dimensions given in U.S. inches
1 inch = 25.4 mm

REPAIR PARTS

TRACTOR- -MODEL NO. ICT14 (JICT14A) PRODUCT NO. 954 13 00-64
STEERING ASSEMBLY

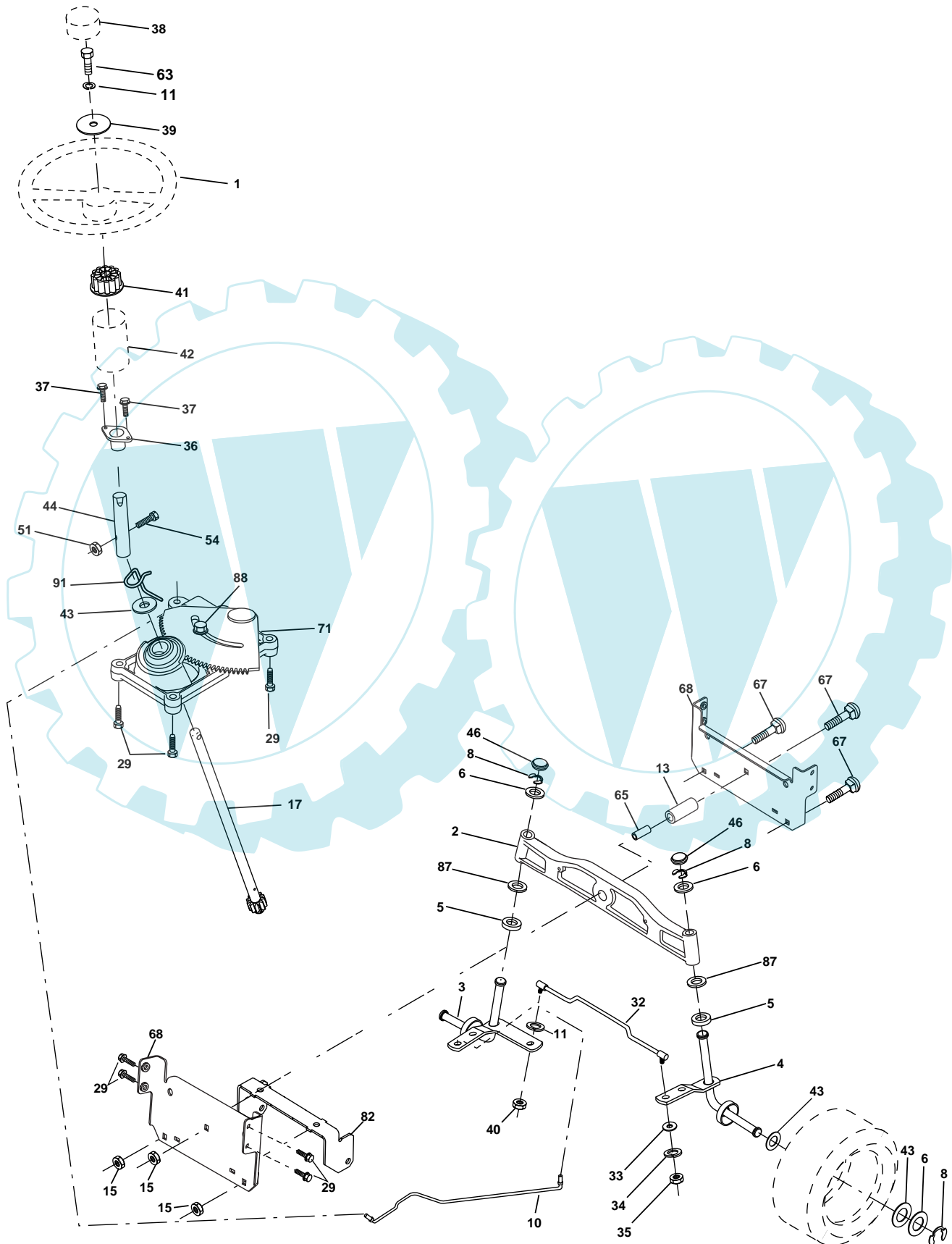

REPAIR PARTS

TRACTOR- -MODEL NO. ICT14 (JICT14A) PRODUCT NO. 954 13 00-64
STEERING ASSEMBLY

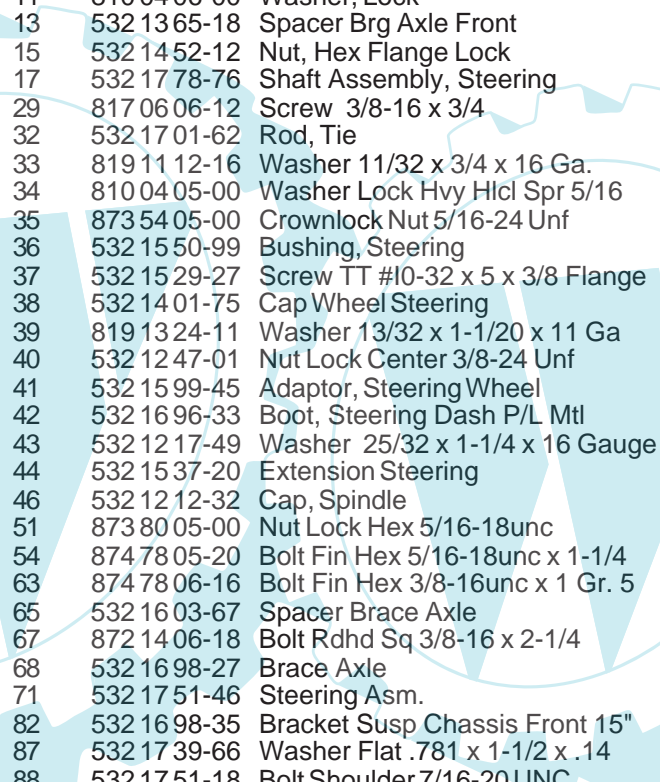

KEY NO.	PART NO.	DESCRIPTION
1	532 17 20-92	Steering Wheel
2	532 17 23-93	Axle Asm Cast Iron Lt
3	532 16 98-40	Spindle Assembly, L.H.
4	532 16 98-39	Spindle Assembly, R.H.
5	532 12 49-31	Washer, Thrust .75 x 1.230
6	532 12 17-48	Washer 25/32 x 1-5/8 x 16 Gauge
8	812 00 00-29	Ring, Klip
10	532 17 51-21	Link, Drag
11	810 04 06-00	Washer, Lock
13	532 13 65-18	Spacer Brg Axle Front
15	532 14 52-12	Nut, Hex Flange Lock
17	532 17 78-76	Shaft Assembly, Steering
29	817 06 06-12	Screw 3/8-16 x 3/4
32	532 17 01-62	Rod, Tie
33	819 11 12-16	Washer 11/32 x 3/4 x 16 Ga.
34	810 04 05-00	Washer Lock Hvy Hlcl Spr 5/16
35	873 54 05-00	Crownlock Nut 5/16-24 Unf
36	532 15 50-99	Bushing, Steering
37	532 15 29-27	Screw TT #10-32 x 5 x 3/8 Flange
38	532 14 01-75	Cap Wheel Steering
39	819 13 24-11	Washer 13/32 x 1-1/20 x 11 Ga
40	532 12 47-01	Nut Lock Center 3/8-24 Unf
41	532 15 99-45	Adaptor, Steering Wheel
42	532 16 96-33	Boot, Steering Dash P/L Mtl
43	532 12 17-49	Washer 25/32 x 1-1/4 x 16 Gauge
44	532 15 37-20	Extension Steering
46	532 12 12-32	Cap, Spindle
51	873 80 05-00	Nut Lock Hex 5/16-18unc
54	874 78 05-20	Bolt Fin Hex 5/16-18unc x 1-1/4
63	874 78 06-16	Bolt Fin Hex 3/8-16unc x 1 Gr. 5
65	532 16 03-67	Spacer Brace Axle
67	872 14 06-18	Bolt Rdhd Sq 3/8-16 x 2-1/4
68	532 16 98-27	Brace Axle
71	532 17 51-46	Steering Asm.
82	532 16 98-35	Bracket Susp Chassis Front 15"
87	532 17 39-66	Washer Flat .781 x 1-1/2 x .14
88	532 17 51-18	Bolt Shoulder 7/16-20 UNC
91	532 17 55-53	Clip Steering

NOTE: All component dimensions given in U.S. inches.
1 inch = 25.4 mm.

REPAIR PARTS

TRACTOR- -MODEL NO. ICT14 (JICT14A) PRODUCT NO. 954 13 00-64
SEAT ASSEMBLY

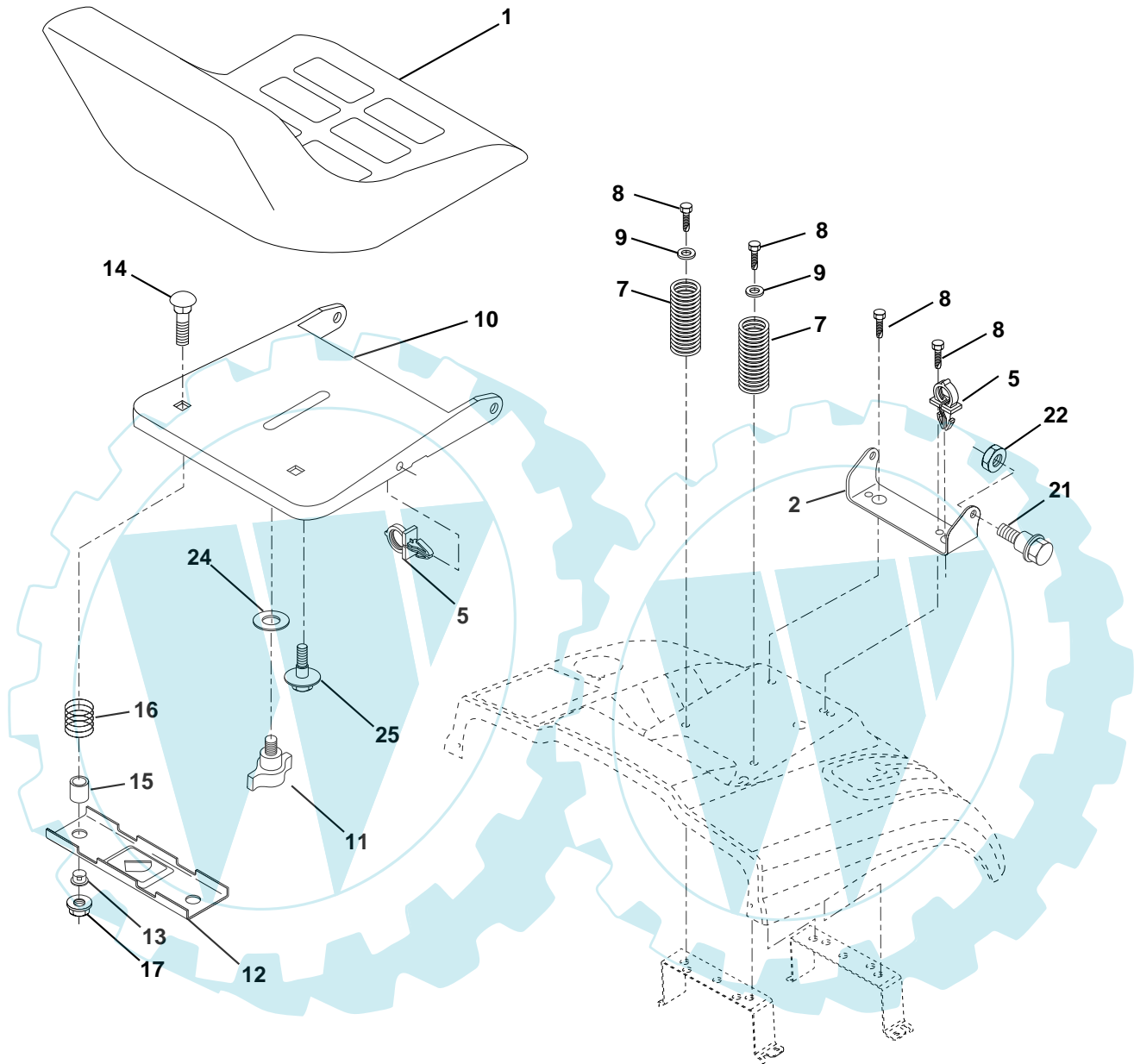

KEY NO.	PART NO.	DESCRIPTION
1	532 14 01-17	Seat
2	532 14 05-51	Bracket Pnt Pivot Seat (blk)
5	532 14 50-06	Clip Push In Hinged
7	532 12 41-81	Spring Seat Cprsn 2 250 Blk Zi
8	817 00 06-16	Screw 3/8-16 X 1.5 Smgml Tap/R.Z
9	819 13 16-14	Washer 13/32 X 1 X 14 Ga
10	532 17 48-94	Pan Assembly Seat Tool-Free
11	532 16 63-69	Knob Seat Adj. Wingnut
12	532 12 12-46	Bracket Pnt Mounting Switch
13	532 12 12-48	Bushing Snap Blk Nyl 50 Id

KEY NO.	PART NO.	DESCRIPTION
14	872 05 04-12	Bolt Rdhd Sht Nk 1/4-20x1-1/2
15	532 13 43-00	Spacer Split
16	532 12 12-50	Spring Cprsn Plate SW 1.310 Ga
17	532 12 39-76	Nut Lock 1/4 Lge Flg Gr 5 Zinc
21	532 17 18-52	Bolt Shoulder 5/16-18 Unc-2A
22	873 80 05-00	Nut Hex Lock w/Ins 5/16-18
24	819 17 19-12	Washer 17/32 X 1-3/16 X 12 Ga.
25	532 12 70-18	Bolt Shoulder 5/16-18 X 62

NOTE: All component dimensions given in U.S. inches.
1 inch = 25.4 mm

REPAIR PARTS

TRACTOR- -MODEL NO. ICT14 (JICT14A) PRODUCT NO. 954 13 00-64

DECALS

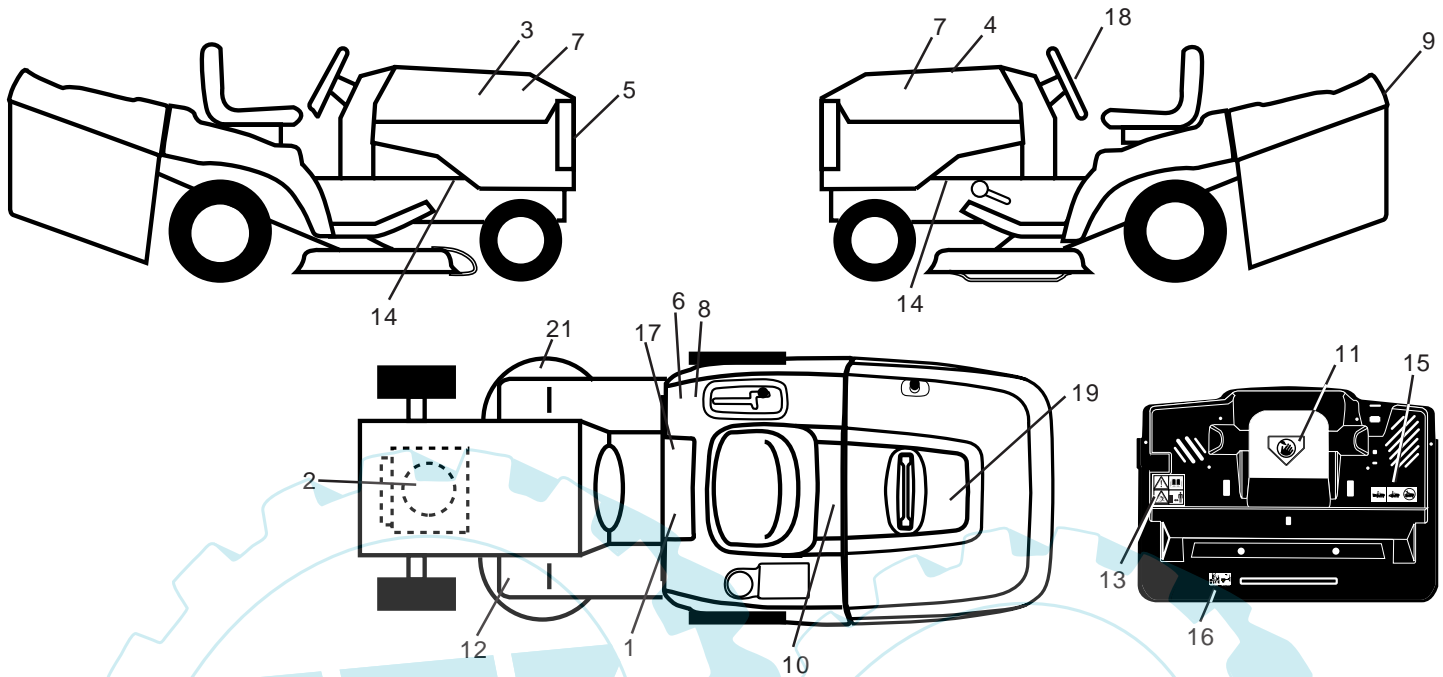

KEY NO.	PART NO.	DESCRIPTION
1	532 14 54-98	Decal Read Owner's Manual Sym
2	532 18 04-31	Decal Hp Engine
3	532 17 96-19	Decal Hood Rh
4	532 17 96-20	Decal Hood Lh
5	532 15 22-62	Decal Grille Logo
6	532 12 61-87	Decal 100 DBA
7	532 16 29-27	Decal Hood Insert
8	532 14 54-37	Decal Europe Stand Ce
9	532 14 17-61	Decal Fender Logo
10	532 14 50-05	Decal Bat Dan/Poi P/L Sym Wpn
11	532 14 54-94	Decal Mower Cut Finger Symbol
12	532 15 97-37	Decal Brake/Clutch Symbol Lt
13	532 16 69-59	Decal Warn Back Plate CRD

KEY NO.	PART NO.	DESCRIPTION
14	532 15 97-36	Decal Chassis Hot Muffler
15	532 16 69-61	Decal Oper Bag Presence CRD
16	532 16 25-98	Decal Drawbar Load Limit
17	532 14 08-37	Decal Saddle Brake Parking
18	532 17 05-65	Decal Ins Strg Whl
19	532 17 06-54	Decal Bagger Top CRD Sup.Vac
21	532 16 62-86	Decal Deck Sch 92 CRD
—	532 13 83-11	Decal Lift Handle
—	532 18 10-91	Pad FTREST LH
—	532 18 10-90	Pad FTREST RH
—	532 17 99-98	Manual Operator's (Euro)
—	532 17 99-99	Manual Operator's (Scand)

WHEELS & TIRES

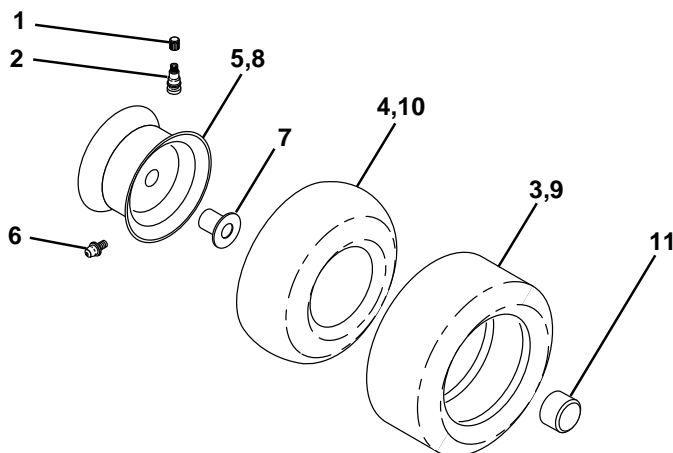

KEY NO.	PART NO.	DESCRIPTION
1	532 05 91-92	Cap Value Tire
2	532 06 51-39	Stem Value
3	532 10 62-22	Tire F Ts 15 X 6 0 - 6 Service
4	532 05 99-04	Tube Inner Front #35060
5	532 13 83-36	Rim Asm 6"front Silver Service
6	532 12 49-57	Fitting Grease
7	532 12 49-59	Bearing Flange
8	532 13 83-37	Rim Asm 8"rear Silver Service
9	532 12 46-35	Tire R Ts 18 x 8.5-8 Service
10	532 12 49-26	Tube Rear 9 5 X 8 Service
11	532 17 50-39	Cap Axle Blk 1 50 X 1 00
--	532 14 43-34	Sealant, Tire (10 oz. tube)

NOTE: All component dimensions given in U.S. inches
1 inch = 25.4 mm

REPAIR PARTS

TRACTOR- -MODEL NO. ICT14 (JICT14A) PRODUCT NO. 954 13 00-64
ENGINE

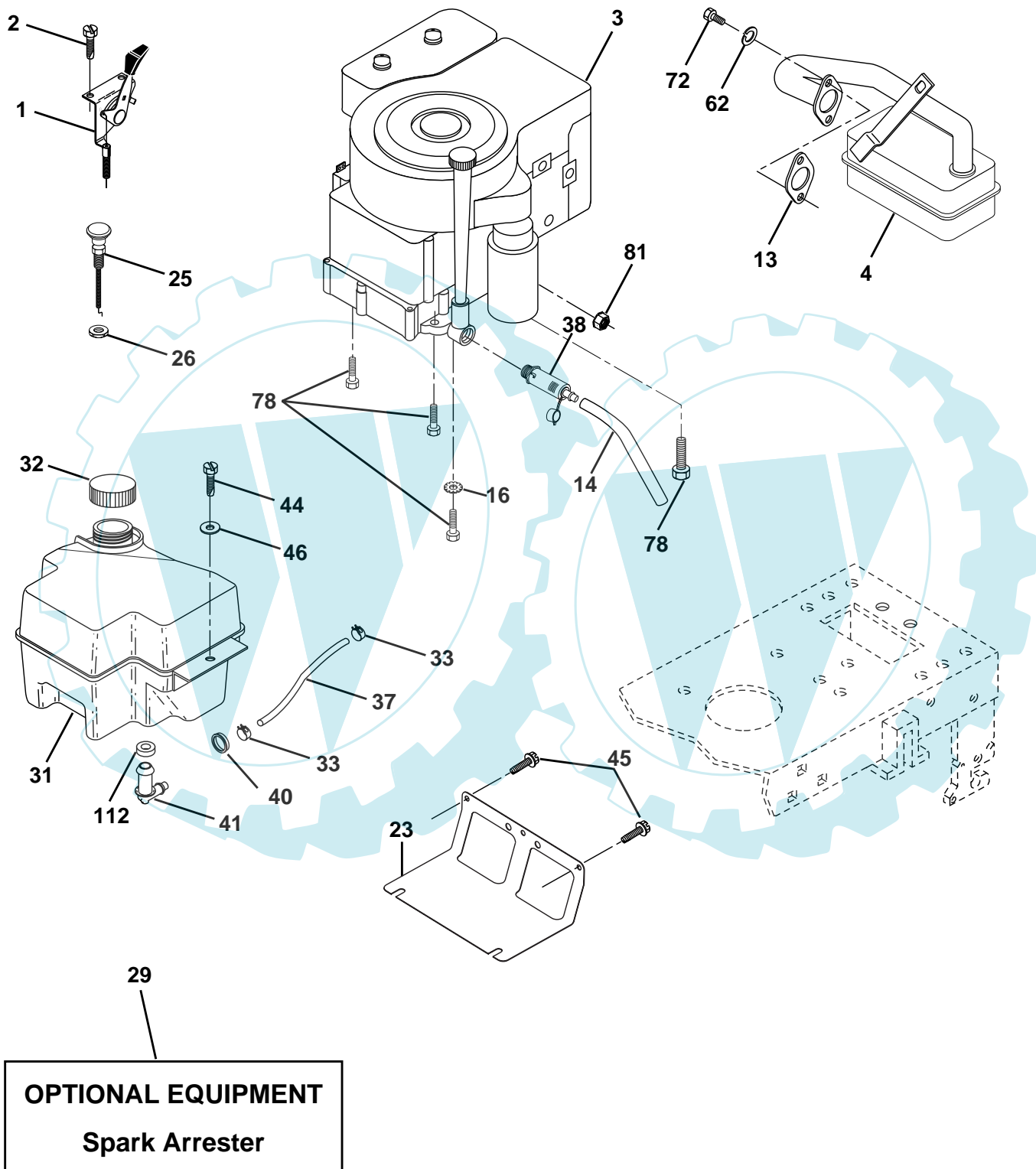

REPAIR PARTS

TRACTOR- -MODEL NO. ICT14 (JICT14A) PRODUCT NO. 954 13 00-64
ENGINE

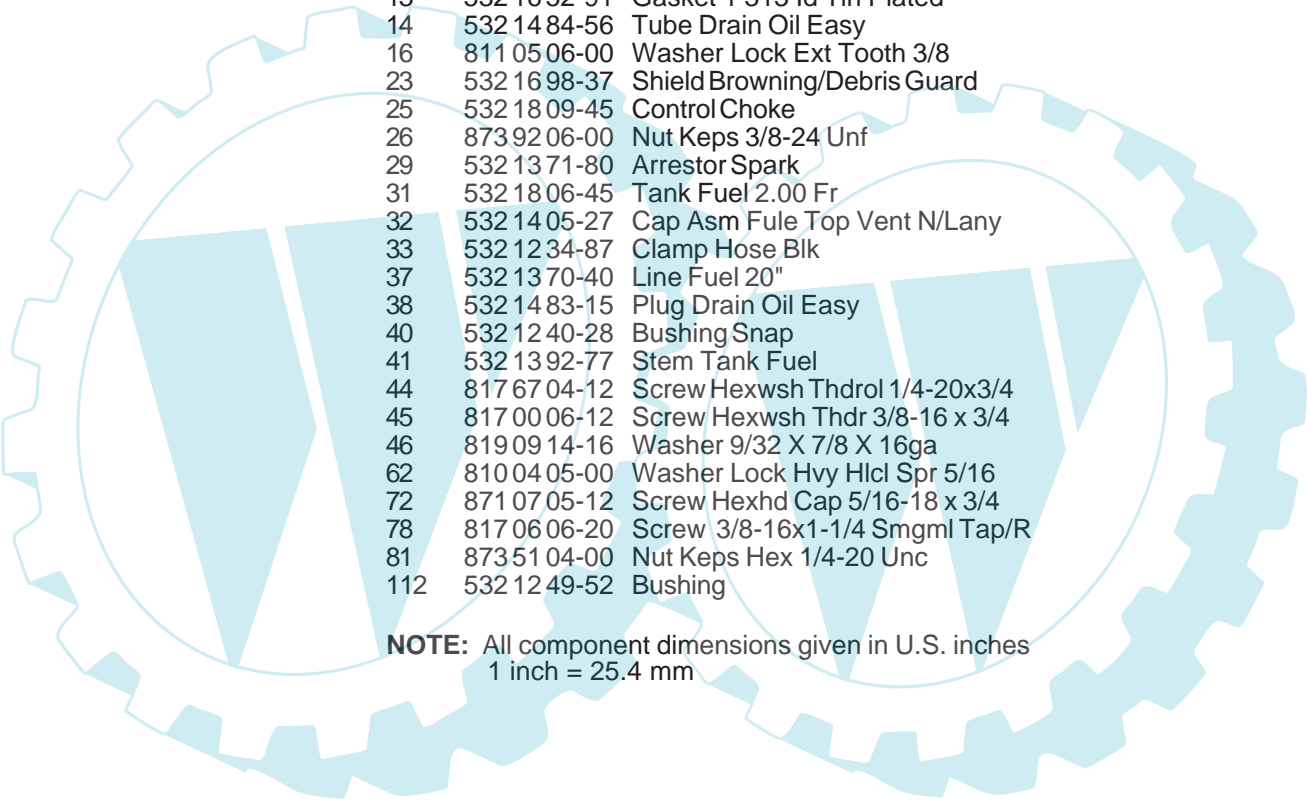

KEY NO.	PART NO.	DESCRIPTION
1	532 17 05-51	Control Throt /Ch Flag
2	817 72 04-08	Screw Hex Thd Cut 1/4-20x1/2
3	-----	Engine Briggs & Stratton Model No. 31G777 (Order Parts from Engine Manufacturer)
4	532 13 73-52	Muffler Exhaust B&S Lt
13	532 16 52-91	Gasket 1 313 Id Tin Plated
14	532 14 84-56	Tube Drain Oil Easy
16	811 05 06-00	Washer Lock Ext Tooth 3/8
23	532 16 98-37	Shield Browning/Debris Guard
25	532 18 09-45	Control Choke
26	873 92 06-00	Nut Keps 3/8-24 Unf
29	532 13 71-80	Arrestor Spark
31	532 18 06-45	Tank Fuel 2.00 Fr
32	532 14 05-27	Cap Asm Fule Top Vent N/Lany
33	532 12 34-87	Clamp Hose Blk
37	532 13 70-40	Line Fuel 20"
38	532 14 83-15	Plug Drain Oil Easy
40	532 12 40-28	Bushing Snap
41	532 13 92-77	Stem Tank Fuel
44	817 67 04-12	Screw Hexwsh Thdrol 1/4-20x3/4
45	817 00 06-12	Screw Hexwsh Thdr 3/8-16 x 3/4
46	819 09 14-16	Washer 9/32 X 7/8 X 16ga
62	810 04 05-00	Washer Lock Hvy Hlcl Spr 5/16
72	871 07 05-12	Screw Hexhd Cap 5/16-18 x 3/4
78	817 06 06-20	Screw 3/8-16x1-1/4 Smgml Tap/R
81	873 51 04-00	Nut Keps Hex 1/4-20 Unc
112	532 12 49-52	Bushing

NOTE: All component dimensions given in U.S. inches
1 inch = 25.4 mm

REPAIR PARTS

TRACTOR- -MODEL NO. ICT14 (JICT14A) PRODUCT NO. 954 13 00-64
MOWER LIFT

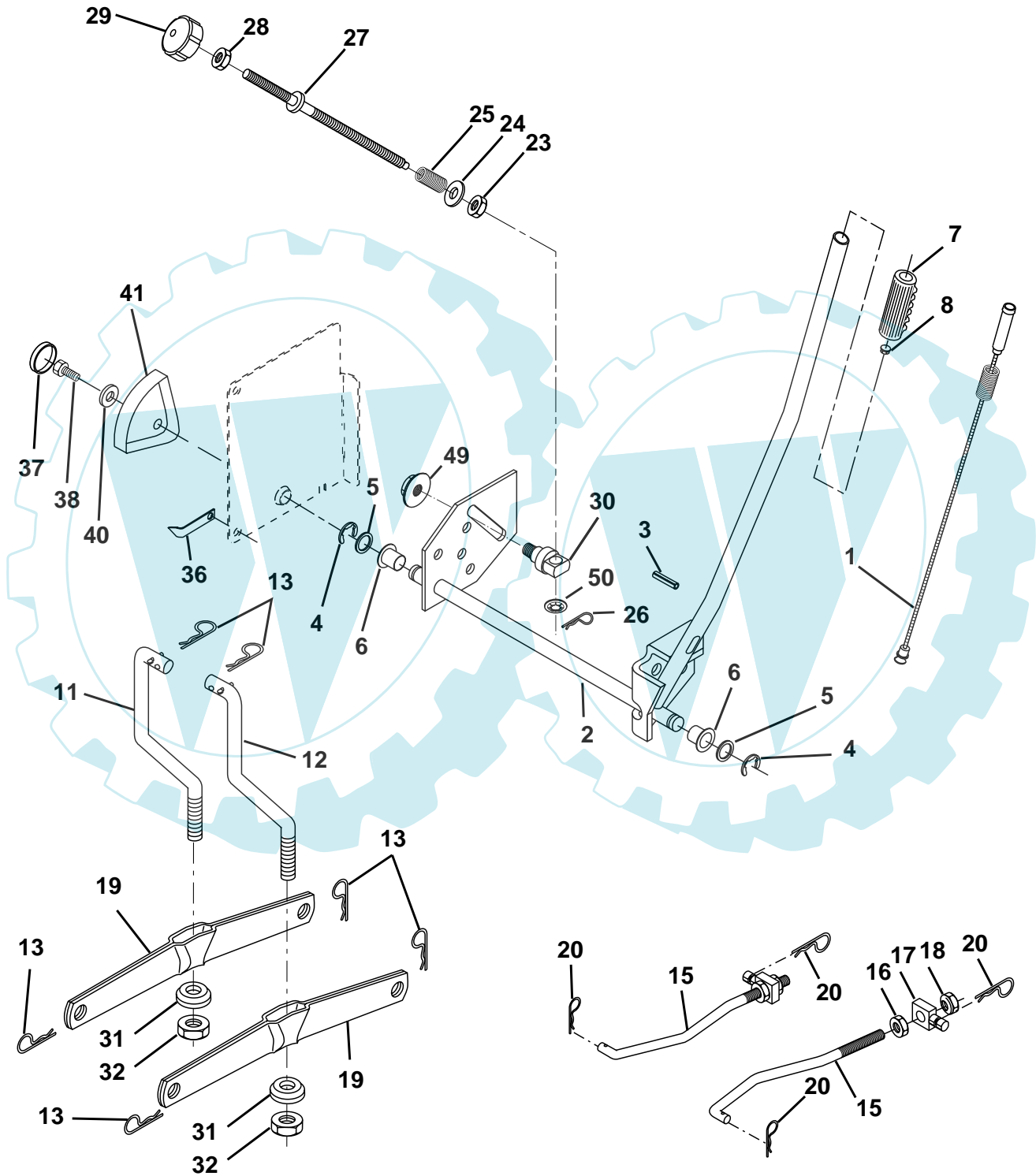

REPAIR PARTS

TRACTOR- -MODEL NO. ICT14 (JICT14A) PRODUCT NO. 954 13 00-64
MOWER LIFT

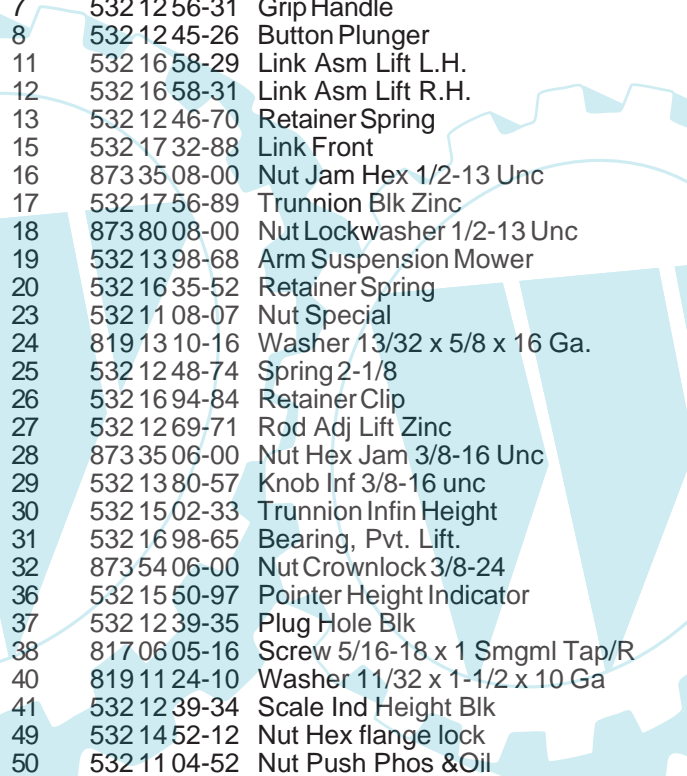

KEY NO.	PART NO.	DESCRIPTION
1	532 15 94-60	Washer Asm Inner Spring W/Plunger
2	532 15 94-71	Shaft Asm. Lift
3	532 10 57-67	Pin Groove
4	812 00 00-02	E Ring #5133-62
5	819 21 16-21	Washer 21/32 x 1 x 21 Ga.
6	532 12 01-83	Bearing Nylon
7	532 12 56-31	Grip Handle
8	532 12 45-26	Button Plunger
11	532 16 58-29	Link Asm Lift L.H.
12	532 16 58-31	Link Asm Lift R.H.
13	532 12 46-70	Retainer Spring
15	532 17 32-88	Link Front
16	873 35 08-00	Nut Jam Hex 1/2-13 Unc
17	532 17 56-89	Trunnion Blk Zinc
18	873 80 08-00	Nut Lockwasher 1/2-13 Unc
19	532 13 98-68	Arm Suspension Mower
20	532 16 35-52	Retainer Spring
23	532 11 08-07	Nut Special
24	819 13 10-16	Washer 13/32 x 5/8 x 16 Ga.
25	532 12 48-74	Spring 2-1/8
26	532 16 94-84	Retainer Clip
27	532 12 69-71	Rod Adj Lift Zinc
28	873 35 06-00	Nut Hex Jam 3/8-16 Unc
29	532 13 80-57	Knob Inf 3/8-16 unc
30	532 15 02-33	Trunnion Infin Height
31	532 16 98-65	Bearing, Pvt. Lift.
32	873 54 06-00	Nut Crownlock 3/8-24
36	532 15 50-97	Pointer Height Indicator
37	532 12 39-35	Plug Hole Blk
38	817 06 05-16	Screw 5/16-18 x 1 Smgml Tap/R
40	819 11 24-10	Washer 11/32 x 1-1/2 x 10 Ga
41	532 12 39-34	Scale Ind Height Blk
49	532 14 52-12	Nut Hex flange lock
50	532 11 04-52	Nut Push Phos &Oil

NOTE: All component dimensions given in U.S. inches
1 inch = 25.4 mm

REPAIR PARTS

TRACTOR- -MODEL NO. ICT14 (JICT14A) PRODUCT NO. 954 13 00-64
MOWER

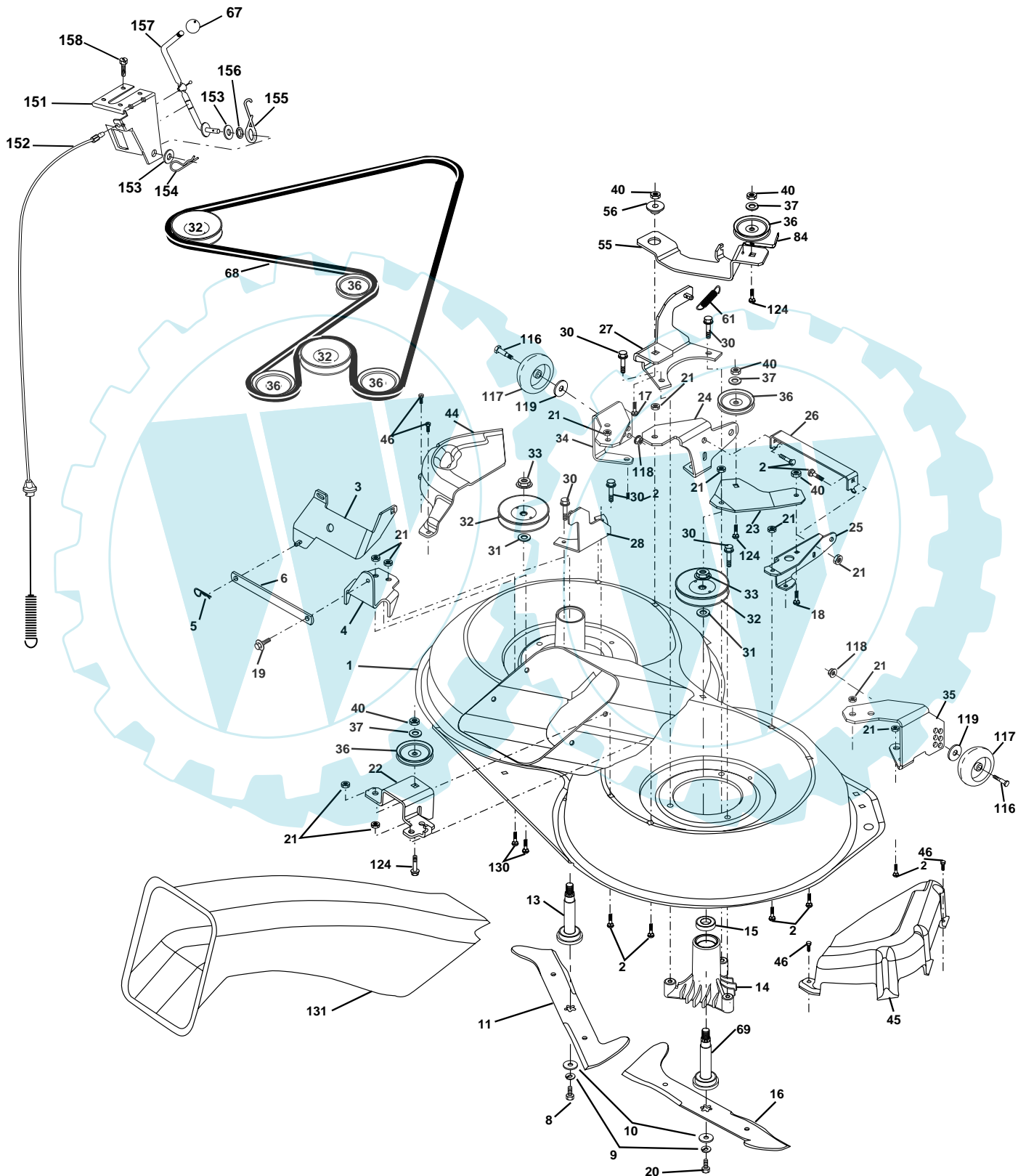

REPAIR PARTS

TRACTOR- -MODEL NO. ICT14 (JICT14A) PRODUCT NO. 954 13 00-64
MOWER

KEY NO.	PART NO.	DESCRIPTION	KEY NO.	PART NO.	DESCRIPTION
1	532 1655-52	Housing Asm. Mower 92 CRD	37	819 13 13-16	Washer 11/32 x 13/16 x 16 Ga
2	872 1405-06	Bolt Rdhd Sqnk 5/16-18 Unc x 3/4	40	873 68 06-00	Nut Crownlock 3/8-16 Unc
3	532 1655-69	Bracket Asm. S-Bar Chass 92 CRD	44	532 17 55-38	Cover Mandrel Lh 92 CRD
4	532 1655-58	Bracket Bar Sway Deck 92 CRD	45	532 17 55-39	Cover Mandrel Rh 92 CRD
5	532 1246-70	Retainer Spring	46	532 13 77-29	Screw Thd Roll 1/4-20 x 5/8
6	532 1655-57	Bar Sway 92 CRD	55	532 16 54-45	Arm Idler 92 CRD
8	532 8508-57	Bolt 3/8-24 x 1.25 Gr8 Patched	56	532 16 57-23	Spacer Retainer Mower
9	810 0306-00	Washer Lock Hvy 3/8 Unplated	61	532 16 59-45	Spring Tension Belt
10	532 1402-96	Washer Hard Blade Mower vented	67	532 10 69-32	Knob Rd 3/8-16 Plstc Thds Blk
11	532 1700-37	Blade 3-1 Lh 92 CRD	68	532 16 55-55	Hex-Belt 92 Mower 105AA
13	532 1376-45	Shaft Asm. W/Lower Bearing	69	532 16 54-82	Shaft Asm W/Lwr Brg Rh Thd CRD
14	532 1287-74	Housing Mandrel Vented (Machd)	84	532 15 60-85	Keeper Belt Idler
15	532 1104-85	Bearing Ball Mandrel	116	532 13 76-44	Bolt Shoulder
16	532 1700-38	Blade 3-1 Rh 92 CRD	117	532 13 39-57	Wheel Gage Donut Wide
17	872 1406-10	Bolt Carriage 3/8-16 x 1-1/4	118	873 93 06-00	Nut Centerlock 3/8-16 Unc
18	872 1106-08	Bolt Rdhd Sqnk 3/8-16 x 1 Gr5	119	819 12 14-14	Washer 3/8 x 7/8 x 14 Ga.
19	532 1328-27	Bolt Shoulder 5/16-18 Thd Form	124	872 11 06-12	Bolt Carr Sh 3/8-16 x 1-1/2 Gr5
20	532 1654-84	Bolt 3/8-24 x 1.25 Gr8 Ptch Lhthd	130	872 11 05-06	Bolt Rdhdsqnk 5/16-18 Unc x 3/4
21	873 68 05-00	Nut Crown Lock 5/16-18	131	532 16 56-61	Chute Bagger CRD 92cm
22	532 1652-43	Bracket Idler Sprt RR 92 CRD	151	532 16 96-70	Bracket Clutch Cable
23	532 1654-46	Bracket Idler Sprt RF 92 CRD	152	532 17 60-74	Clutch Cable CRD
24	532 1652-42	Bracket Suspension LF 92 CRD	153	532 16 96-74	Washer Flat 3/8" Tupe B
25	532 1652-44	Bracket Suspension RF 92 CRD	154	532 16 96-75	Spring Retainer
26	532 1652-37	Brace Support Susp Frt CRD	155	532 16 96-71	Spring Retention Lvr Cltch Cab
27	532 1655-68	Bracket Asm. Susp RR 92 CRD	156	532 16 96-72	Spacer Clutch Cable
28	532 1655-67	Bracket Asm. Susp LR 92 CRD	157	532 16 96-69	Rod Clutch Cable 3/8"
30	532 17 39-84	Screw Thd Rolling Washer Head	158	817 72 04-08	Screw Hex Thd Cut 1/4-20 x 1/2
31	532 12 99-63	Washer Spacer Mower Vented	-	532 13 07-94	Mandrel Asm Service
32	532 15 35-31	Mandrel Pulleys 36 & 46	-	532 16 55-79	Mandrel Asm CRD Lh Threads SVC
33	532 17 83-42	Nut Flg Top Lock Cntr B 9/16	-	532 18 06-44	Replacement Mower Complete
34	532 16 52-39	Bracket Gauge Wheel Lf 92 CRD			
35	532 16 52-38	Bracket Gauge Wheel Rf 92 CRD			
36	532 14 67-63	Pulley Idler V-Groove Dim 4.25			

NOTE: All component dimensions given in U.S. inches
1 inch = 25.4 mm

REPAIR PARTS

TRACTOR- -MODEL NO. ICT14 (JICT14A) PRODUCT NO. 954 13 00-64
BAGGER

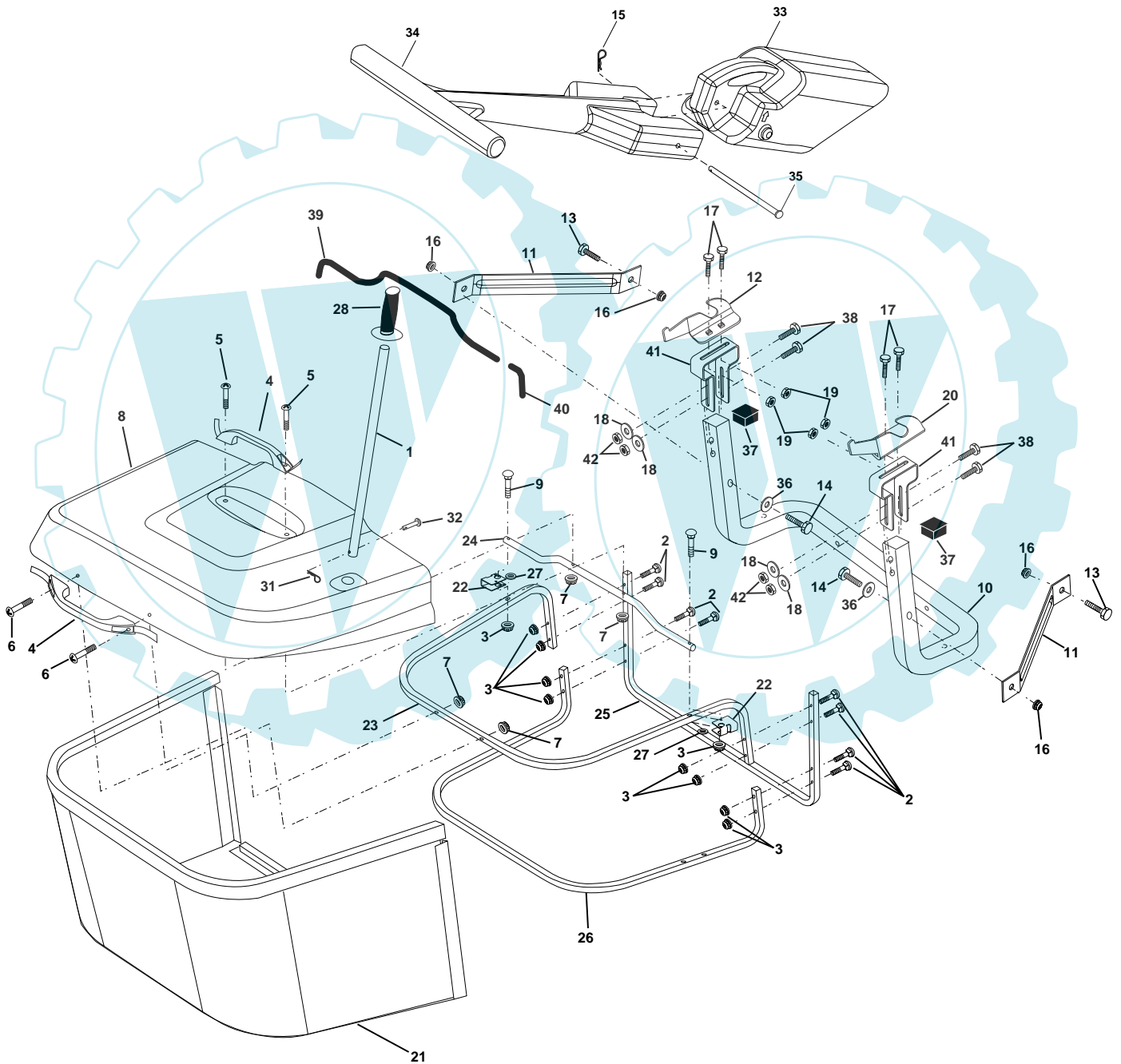

REPAIR PARTS

TRACTOR- -MODEL NO. ICT14 (JICT14A) PRODUCT NO. 954 13 00-64
BAGGER

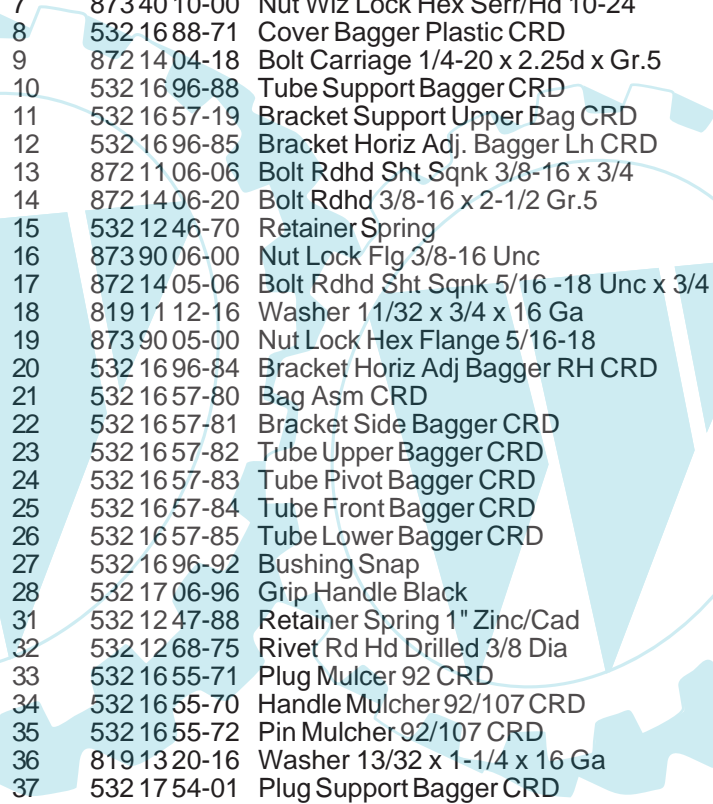

KEY NO.	PART NO.	DESCRIPTION
1	532 17 06-90	Tube Handle Bagger CRD
2	872 14 04-16	Bolt Carriage 1/4-20 x 2.0 Gr.5
3	532 12 39-76	Nut Lock 1/4 Lge Flg Gr. 5 Zinc
4	532 16 99-16	Handle Grab Plastic Black W/Lvrs
5	874 98 10-24	Screw Pan Head #10-24 x 1.50 Blk
6	874 98 10-32	Screw Pan Hd
7	873 40 10-00	Nut Wiz Lock Hex Serr/Hd 10-24
8	532 16 88-71	Cover Bagger Plastic CRD
9	872 14 04-18	Bolt Carriage 1/4-20 x 2.25d x Gr.5
10	532 16 96-88	Tube Support Bagger CRD
11	532 16 57-19	Bracket Support Upper Bag CRD
12	532 16 96-85	Bracket Horiz Adj. Bagger Lh CRD
13	872 11 06-06	Bolt Rdhd Sht Sqnk 3/8-16 x 3/4
14	872 14 06-20	Bolt Rdhd 3/8-16 x 2-1/2 Gr.5
15	532 12 46-70	Retainer Spring
16	873 90 06-00	Nut Lock Flg 3/8-16 Unc
17	872 14 05-06	Bolt Rdhd Sht Sqnk 5/16 -18 Unc x 3/4
18	819 11 12-16	Washer 11/32 x 3/4 x 16 Ga
19	873 90 05-00	Nut Lock Hex Flange 5/16-18
20	532 16 96-84	Bracket Horiz Adj Bagger RH CRD
21	532 16 57-80	Bag Asm CRD
22	532 16 57-81	Bracket Side Bagger CRD
23	532 16 57-82	Tube Upper Bagger CRD
24	532 16 57-83	Tube Pivot Bagger CRD
25	532 16 57-84	Tube Front Bagger CRD
26	532 16 57-85	Tube Lower Bagger CRD
27	532 16 96-92	Bushing Snap
28	532 17 06-96	Grip Handle Black
31	532 12 47-88	Retainer Spring 1" Zinc/Cad
32	532 12 68-75	Rivet Rd Hd Drilled 3/8 Dia
33	532 16 55-71	Plug Mulcher 92 CRD
34	532 16 55-70	Handle Mulcher 92/107 CRD
35	532 16 55-72	Pin Mulcher 92/107 CRD
36	819 13 20-16	Washer 13/32 x 1-1/4 x 16 Ga
37	532 17 54-01	Plug Support Bagger CRD
38	872 01 05-20	Bolt 5/16-18 x 2.50
39	532 16 99-99	Seal 26"
40	532 17 00-00	Seal 7"
41	532 16 96-83	Bracket Vert Adj. Bagger CRD
42	873 80 05-00	Nut Lock Hx w/Ins 5/16-18 Unc

NOTE: All component dimensions given in U.S. inches
1 inch = 25.4 mm